

compression cam latch

**C3-1529**



RL

IP65

SERIES

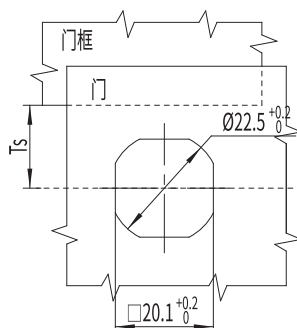
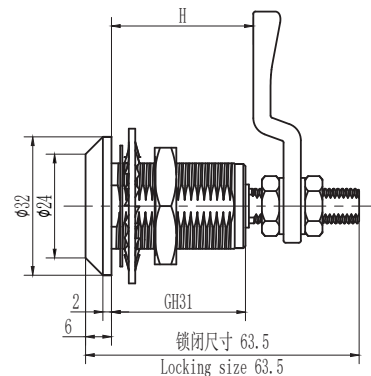
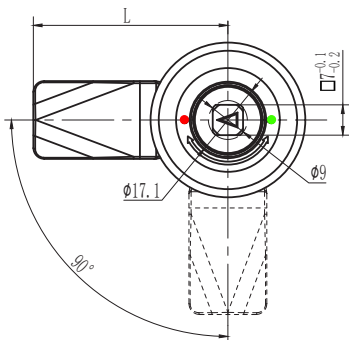

**锁芯 Cylinder**



**选型 Model selection**

锁芯选型  
Lock cylinder selection

A1 代表 SUS304  
A1 represents SUS304  
A2 代表 SUS316  
A2 represents SUS316

**C3-1529-SX-LH-A1L**

L 代表钢栓长度  
L represents the length of the steel bolt  
H 代表有效高度  
H represents effective height

**旋转 Rotate**



如需获得产品 3D 模型图，请联系 WWW.FORND.COM

1. Material and surface treatment:  
Main body, Steel bolt: SUS304 or SUS316  
Sealing ring: EPDM foam.

2. Performance parameters:  
Protection class: IP65  
Unlocking torque:  $\leq 0.79\text{N}\cdot\text{M}$   
Ultimate load: 700N  
Tensioning and stretching amount: 7mm

3. Installation instructions:  
Fixed screw torque 10N. M  
Fixed nut torque 17N. M  
Applicable door panel thickness: 1-15mm

1. 材质及表面处理:  
主体, 钢栓: SUS304 或 SUS316  
密封圈: EPDM发泡胶。

2. 性能参数:  
防护等级: IP65  
解锁扭矩: 小于等于 0.79N·M  
极限载荷: 700N  
拉紧伸缩量: 7mm

3. 安装说明:  
固定螺丝扭矩 10N.M  
固定螺母扭矩 17N.M  
适用门板厚度: 1-15mm