

C3-1534

compression cam latch

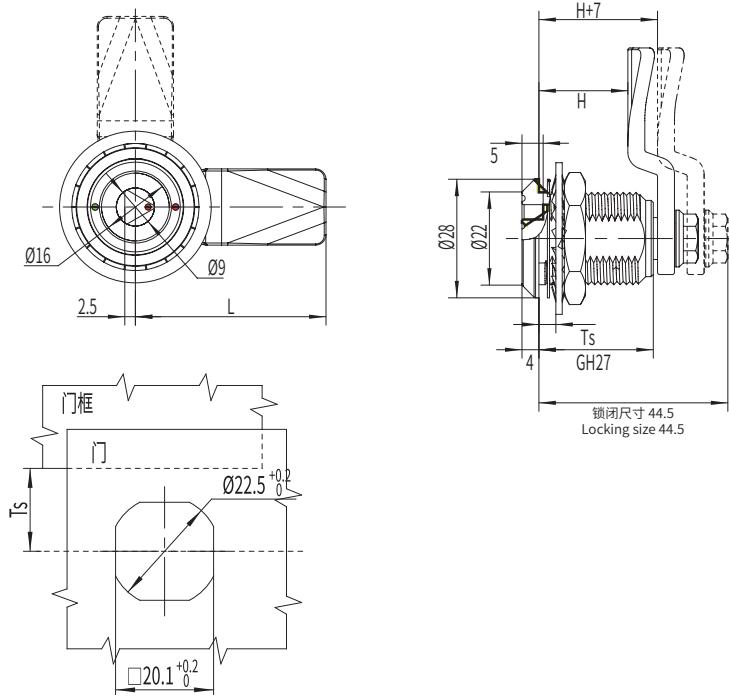

锁芯 Cylinder



选型 Model selection

锁芯选型
Lock cylinder selection

C3-1534-SX-LH-A1L

30 代表电镀亮铬
30 represents electroplating bright chrome
40 代表喷塑亚光黑
40 represents Black powder coated
A1 代表 SUS304
A1 represents SUS304

L 代表钢柱长度
L represents the length of the steel bolt
H 代表有效高度
H represents effective height

旋转 Rotate

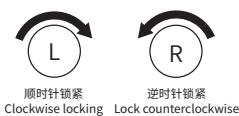

1. Material and surface treatment:
Main body, Steel bolt: SUS304 or SUS316
Sealing ring: EPDM foam.

2. Performance parameters:
Protection class: IP65
Unlocking torque: $\leq 0.79\text{N}\cdot\text{M}$
Ultimate load: 700N
Tensioning and stretching amount: 7mm

3. Installation instructions:
Fixed screw torque 8N. M
Fixed nut torque 17N. M
Applicable door panel thickness: 1-15mm

1. 材质及表面处理:
主体, 钢柱: SUS304 或 SUS316
密封圈: EPDM发泡胶。

2. 性能参数:
防护等级: IP65
解锁扭矩: 小于等于 0.79N·M
极限载荷: 700N
拉紧伸缩量: 7mm

3. 安装说明:
固定螺丝扭矩 8N.M
固定螺母扭矩 17N.M
适用门板厚度: 1-15mm

如需获得产品 3D 模型图，请联系 WWW.FORND.COM