

## H2-2352

## External Hinge

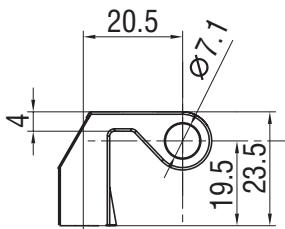
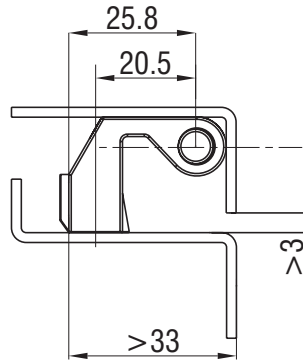
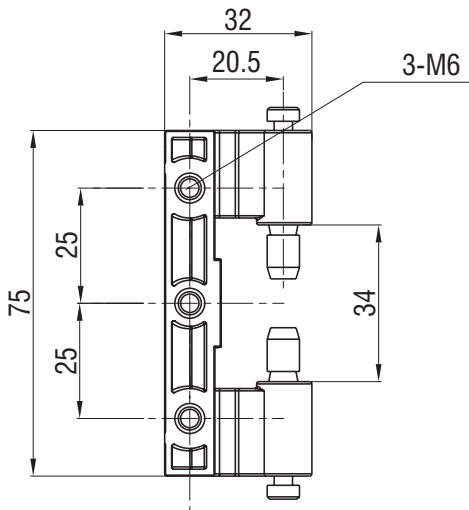

A 型 Version A

B 型 Version B

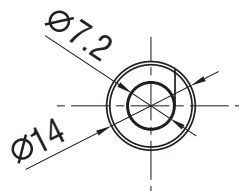
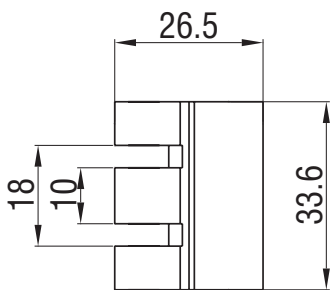
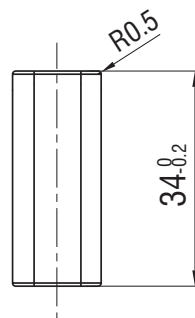
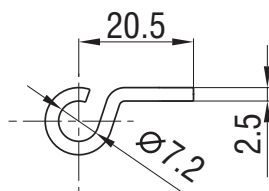

如需获得产品 3D 模型图，请联系 WWW.FORND.COM

	喷塑麻面黑 Black Textured Powder Coated	喷沙 Sand sprayed	SUS304
A 型 Version A	H2-2352-42A	H2-2352-39A	H2-2352-A1A
B 型 Version B	H2-2352-42B	H2-2352-39B	H2-2352-A1A

1. Material and surface treatment:  
Main body : Zamak DIN-EN 1774-ZnAl4Cu1  
or SUS304

1. 材质及表面处理:  
主体: 5# 锌合金 或 SUS304